

Single Phase Motors-Aluminum Frame - PSPMY80A4 B35

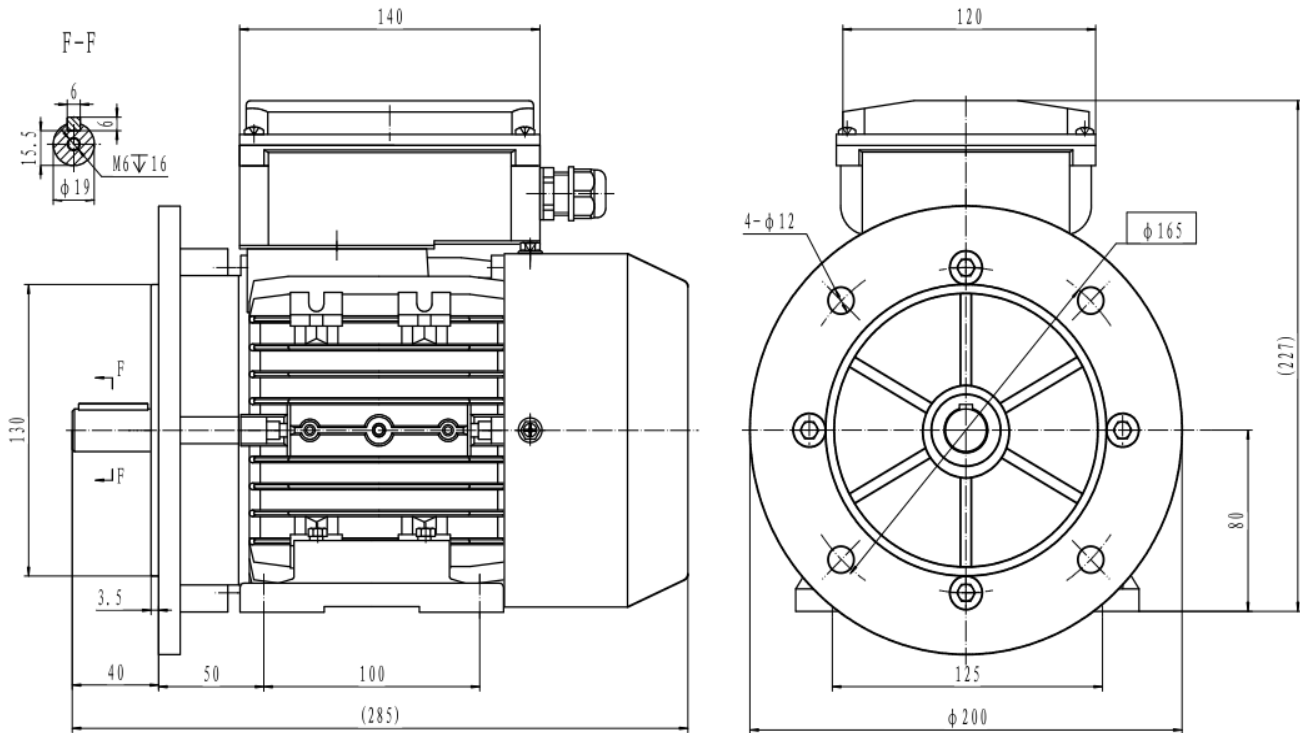

Type	PSPMY80A4
Frame Size	80
Capacity	0.55kW
Speed / Pole	1430 RPM / 4 Pole
Mounting Position	IMB35
Insulation Class	F
Protection Class	IP55
Duty Cycle	S1 Continuous
Temperature Rise Class	B
Ambient temp. (°C)	45°C
Cooling method	IC411 self-Ventilated
Power Factor COS (phi)	0.96

Efficiency	IE1 Efficiency
T-starting / T-nominal	0.35
T-max/Tn	1.7
Full Load Torque	3.67Nm
I-starting / I-nominal	3.9
Noise	70 dB
Bearing DE	6204 C3
Bearing NDE	6204 C3
Weight (kg)	9
Run capacitor value	20 µF
Run capacitor voltage	450V

Electrical data:

Rated Power (kW)	0.55
Frequency (Hz)	50
Voltage (V)	230
Speed (RPM)	1430
Full load current (A)	3.85