

Single Phase Motors-Aluminum Frame - PSPML90L4 B5

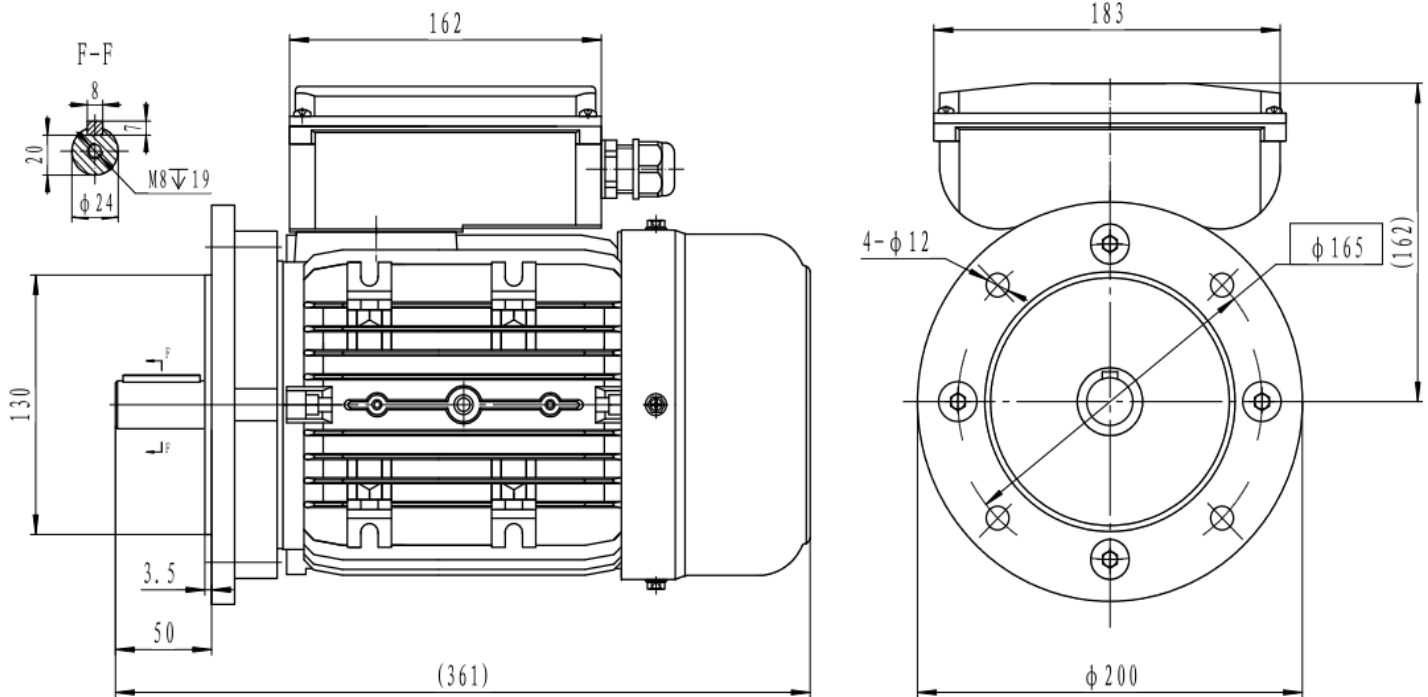

Type	PSPML90L4
Frame Size	90
Capacity	1.5kW
Speed / Pole	1410 RPM / 4 Pole
Mounting Position	IMB5
Insulation Class	F
Protection Class	IP55
Duty Cycle	S1 Continuous
Temperature Rise Class	B
Ambient temp. (°C)	45°C
Cooling method	IC411 self-Ventilated
Power Factor COS (phi)	0.95
I-starting / I-nominal	5

Efficiency	IE1 Efficiency
T-starting / T-nominal	2.5
T-max/Tn	1.8
Full Load Torque	10.16Nm
Centrifugal switch	Electronic centrifugal switch
Noise	78 dB
Bearing DE	6205
Bearing NDE	6204
Weight (kg)	16
Run capacitor value	40 µF
Run capacitor voltage	450V
Start capacitor value	200 µF
Start capacitor voltage	250V

Electrical data:

Rated Power (kW)	1.5
Frequency (Hz)	50
Voltage (V)	230
Speed (RPM)	1410
Full load current (A)	8.45