

Three Phase Electric Motors-Cast iron Frame - PM2C200LA2-B3

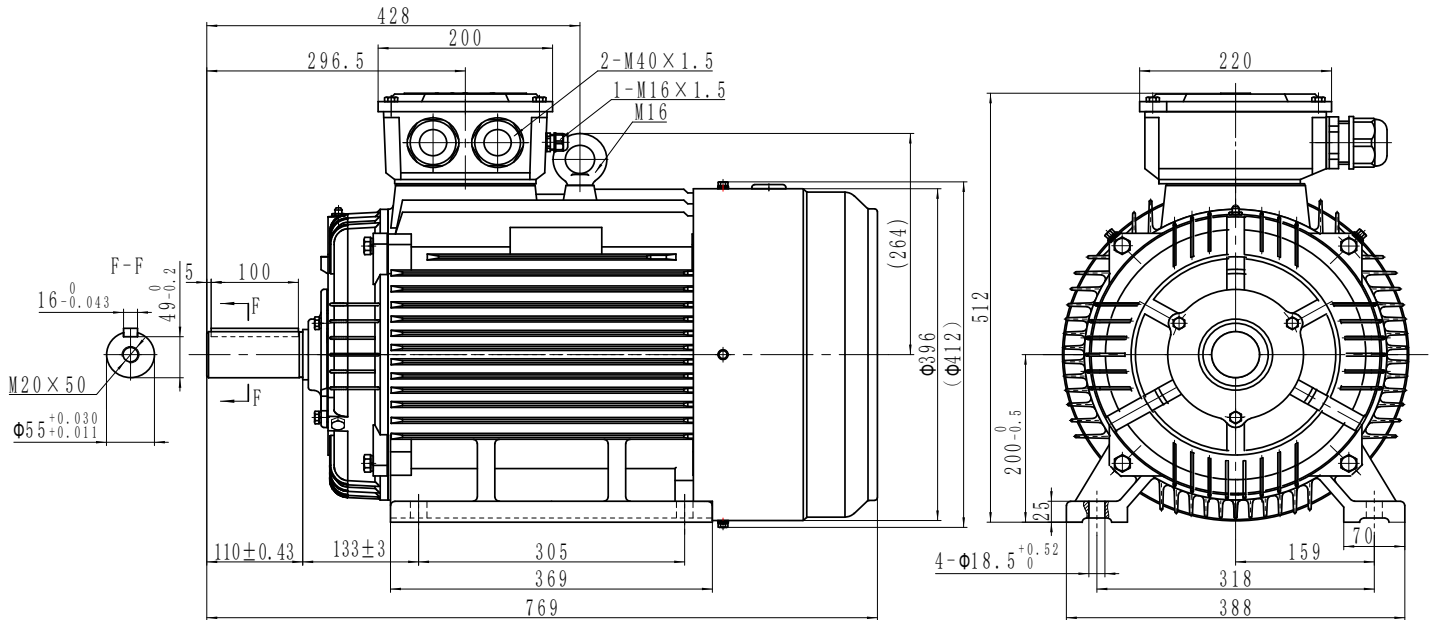

Type	PM2C200LA2-B3
Frame Size	200L
Capacity	30kW
Speed / Pole	2950 RPM / 2 Pole
Mounting Position	IMB3
Insulation Class	F
Protection Class	IP55
Duty Cycle	S1 Continuous
Temperature Rise Class	B
Ambient temp. (°C)	45°C
Cooling method	IC411 self-Ventilated

Efficiency	IE2 Efficiency (92.0%)
Power Factor COS (phi)	89%
I-starting / I-nominal	7.5
T-starting / T-nominal	2.2
T-max/Tn	2.3
Full Load Torque	97Nm
Thermal protection	PTC thermistor
Noise	81.2dB
Bearing DE	SKF 6212
Bearing NDE	SKF 6212
Weight (kg)	246

Electrical data:

Rated Power (kW)	30	29.1	36	34.9			
Frequency (Hz)	50	50	60	60			
Voltage (V)	400	690	380	660	480	830	440
Speed (RPM)	2950	2950	2950	2950	3540	3540	3540
Connection	Δ	Y	Δ	Y	Δ	Y	Δ
Full load current (A)	53	30.7	54	34	53	30.7	57