

Three Phase Electric Motors-Aluminum Frame - PM2A90L4

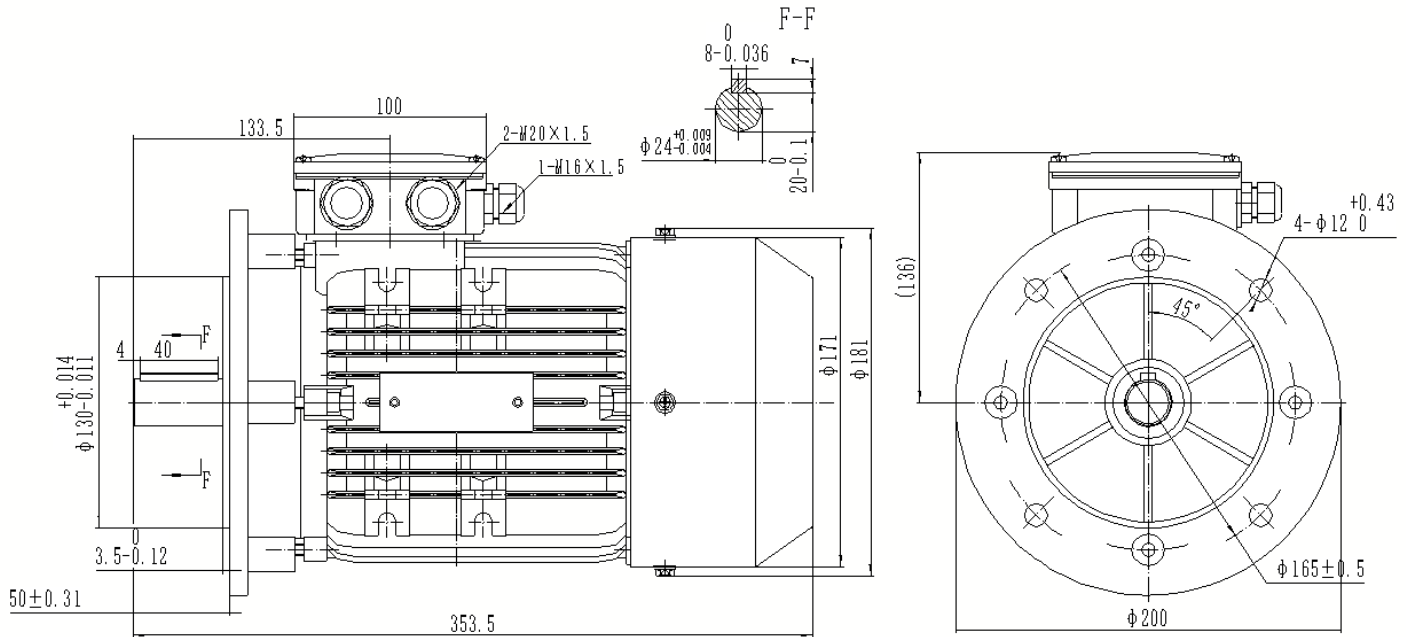

Type	PM2A90L4 PTC
Frame Size	90L
Capacity	1.5 kW
Speed / Pole	1450RPM / 4 Pole
Mounting Position	IMB5
Insulation Class	F
Protection Class	IP55
Duty Cycle	S1 Continuous
Temperature Rise Class	B
Ambient temp. (°C)	45°C
Cooling method	IC411 self-Ventilated

Efficiency	IE2 Efficiency (82.8%)
Power Factor COS (phi)	71%
I-starting / I-nominal	6.6
T-starting / T-nominal	2.7
T-max/Tn	3.4
Full Load Torque	9.9Nm
Thermal protection	PTC thermistor
Noise	54 dB
Bearing DE	SKF 6205 ZZC3
Bearing NDE	SKF 6205 ZZC3
Weight (kg)	16.3

Electrical data:

Rated Power (kW)	1.5		1.46		1.8		1.75
Frequency (Hz)	50		50		60		60
Voltage (V)	230	400	220	380	276	480	440
Speed (RPM)	1450	1450	1450	1450	1730	1730	1730
Connection	Δ	Y	Δ	Y	Δ	Y	Y
Full load current (A)	5.91	3.4	6.22	3.6	5.91	3.4	3.6