

Three Phase Electric Motors-Aluminum Frame - PM1A80C2

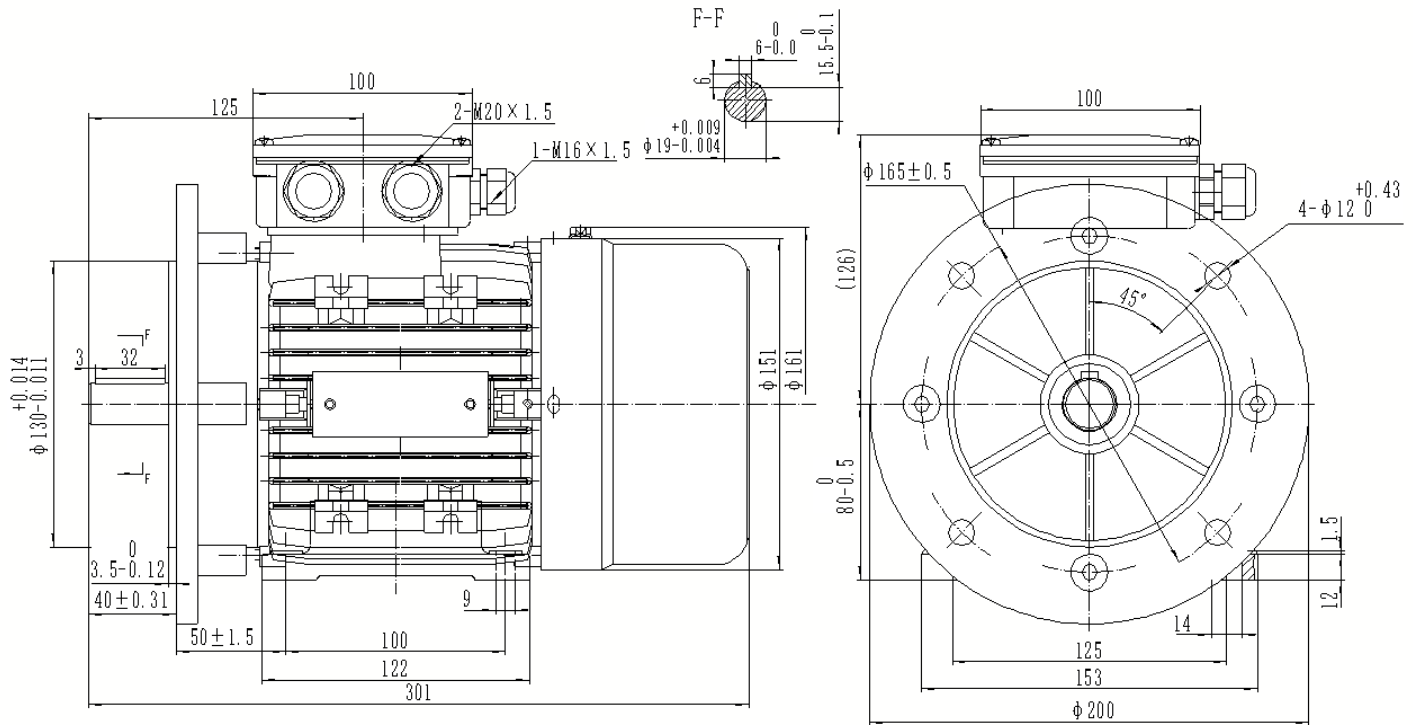

Type	PM1A80C2 PTC
Frame Size	80
Capacity	1.5kW
Speed / Pole	2730 RPM / 2 Pole
Mounting Position	IMB35
Insulation Class	F
Protection Class	IP55
Duty Cycle	S1 Continuous
Temperature Rise Class	B
Ambient temp. (°C)	45°C
Cooling method	IC411 self-Ventilated

Efficiency	IE1 Efficiency
Power Factor COS (phi)	84%
I-starting / I-nominal	6.0
T-starting / T-nominal	2.8
T-max/Tn	3.1
Full Load Torque	5.2Nm
Thermal protection	PTC thermistor
Noise	72dB
Bearing DE	SKF 6204 C3
Bearing NDE	SKF 6204 C3
Weight (kg)	12.5

Electrical data:

Rated Power (kW)	1.5	1.46	1.7	1.7
Frequency (Hz)	50	50	60	60
Voltage (V)	230 400	220 380	276 480	440
Speed (RPM)	2730 2730	2730 2730	3310 3310	3310
Connection	Δ Y	Δ Y	Δ Y	Y
Full load current (A)	5.57 3.2	5.87 3.4	5.57 3.2	3.4