

Three Phase Electric Motors-Aluminum Frame - PM1A71C4

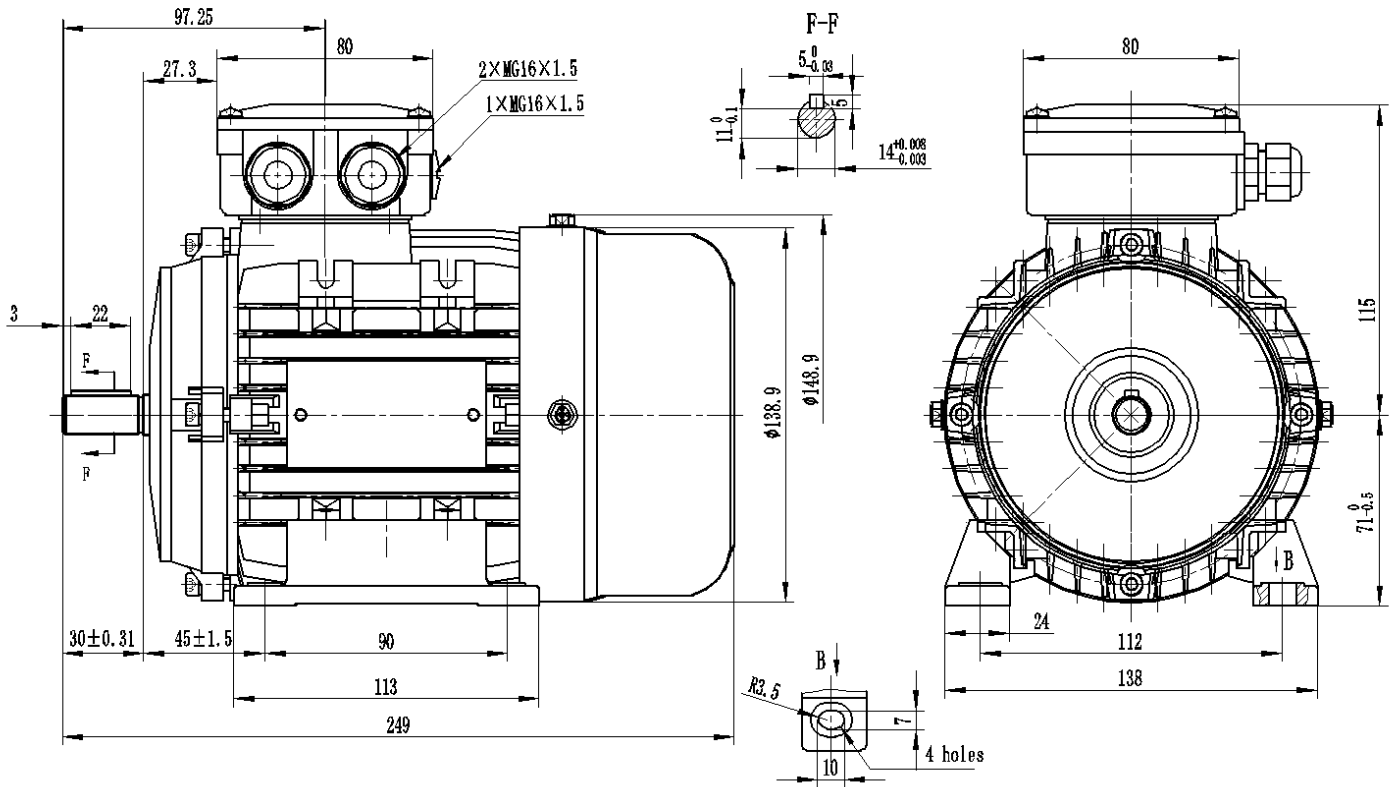

Type	PM1A71C4 PTC
Frame Size	71
Capacity	0.55 kW
Speed / Pole	1360 RPM / 4 Pole
Mounting Position	IMB3
Insulation Class	F
Protection Class	IP55
Duty Cycle	S1 Continuous
Temperature Rise Class	B
Ambient temp. (°C)	45°C
Cooling method	IC411 self-Ventilated

Efficiency	IE1 Efficiency
Power Factor COS (phi)	72%
I-starting / I-nominal	6.0
T-starting / T-nominal	2.2
T-max/Tn	2.4
Full Load Torque	3.8Nm
Thermal protection	PTC thermistor
Noise	58dB
Bearing DE	SKF 6202 C3
Bearing NDE	SKF 6202 C3
Weight (kg)	7.5

Electrical data:

Rated Power (kW)	0.55	0.53	0.66	0.64
Frequency (Hz)	50	50	60	60
Voltage (V)	230 400	220 380	276 480	440
Speed (RPM)	1360 1360	1360 1360	1620 1620	1620
Connection	Δ Y	Δ Y	Δ Y	Y
Full load current (A)	2.78 1.6	2.94 1.7	2.78 1.6	1.7