

Three Phase Electric Motors-Aluminum Frame - PM1A71C2

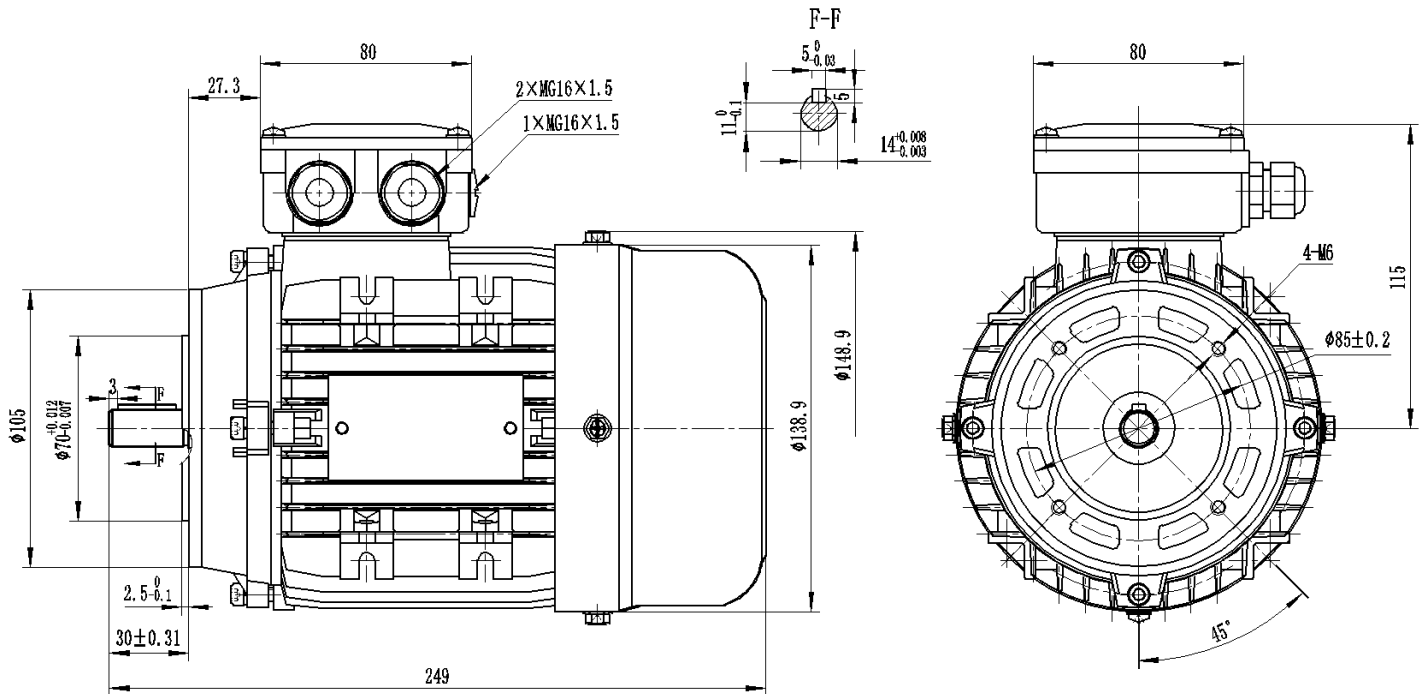

Type	PM1A71C2 PTC
Frame Size	71
Capacity	0.75kW
Speed / Pole	2730 RPM / 2 Pole
Mounting Position	IMB14
Insulation Class	F
Protection Class	IP55
Duty Cycle	S1 Continuous
Temperature Rise Class	B
Ambient temp. (°C)	45°C
Cooling method	IC411 self-Ventilated

Efficiency	IE1 Efficiency
Power Factor COS (phi)	80%
I-starting / I-nominal	6.0
T-starting / T-nominal	2.6
T-max/Tn	2.9
Full Load Torque	2.6Nm
Thermal protection	PTC thermistor
Noise	67dB
Bearing DE	SKF 6202 C3
Bearing NDE	SKF 6202 C3
Weight (kg)	8

Electrical data:

Rated Power (kW)	0.75		0.73		0.87		0.87
Frequency (Hz)	50		50		60		60
Voltage (V)	230	400	220	380	276	480	440
Speed (RPM)	2730	2730	2730	2730	3310	3310	3310
Connection	Δ	Y	Δ	Y	Δ	Y	Y
Full load current (A)	3.48	2.0	3.63	2.1	3.48	2.0	2.1