

Three Phase Electric Motors-Aluminum Frame - PM1A112M8

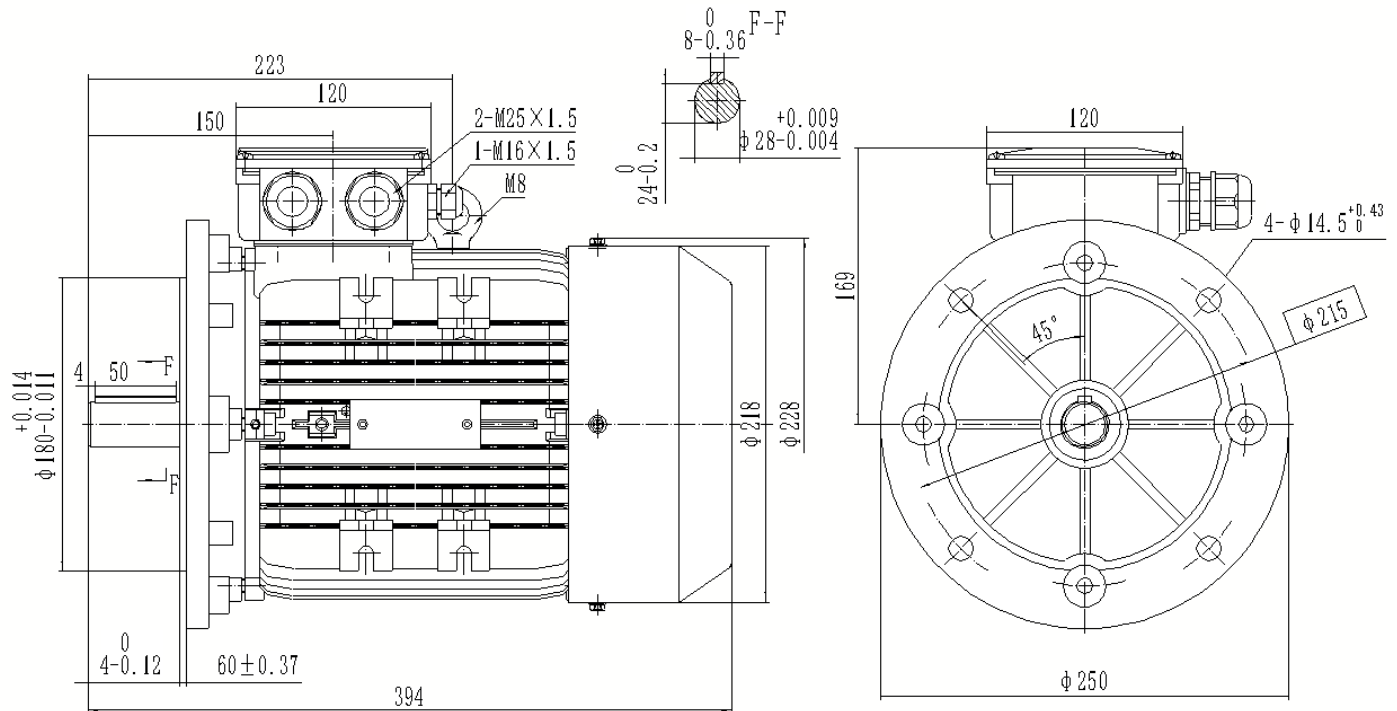

Type	PM1A112M8 PTC
Frame Size	112
Capacity	1.5kW
Speed / Pole	700 RPM / 8Pole
Mounting Position	IMB5
Insulation Class	F
Protection Class	IP55
Duty Cycle	S1 Continuous
Temperature Rise Class	B
Ambient temp. (°C)	45°C
Cooling method	IC411 self-Ventilated

Efficiency	IE1 Efficiency
Power Factor COS (phi)	68%
I-starting / I-nominal	6
T-starting / T-nominal	2.2
T-max/Tn	2.4
Full Load Torque	20Nm
Thermal protection	PTC thermistor
Noise	61dB
Bearing DE	SKF 6306 C3
Bearing NDE	SKF 6306 C3
Weight (kg)	34

Electrical data:

Rated Power (kW)	1.5	1.46	1.7	1.7			
Frequency (Hz)	50	50	60	60			
Voltage (V)	230	400	220	380	276	480	440
Speed (RPM)	700	700	700	700	840	840	840
Connection	Δ	Y	Δ	Y	Δ	Y	Y
Full load current (A)	7.83	4.5	8.12	4.7	7.83	4.5	4.7